



# CÔNG TY TNHH KỸ THUẬT DƯƠNG HÙNG DHE

HỆ THỐNG SẢN PHẨM MÁNG CÁP DHE

Tư vấn khách hàng: Mr.Hùng . SDT: 0908855090

Hỗ trợ kỹ thuật : Mr.Tài . SDT: 0344282873

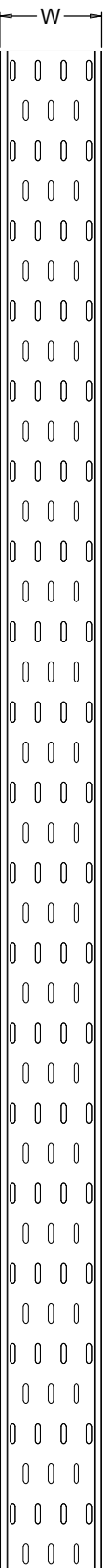
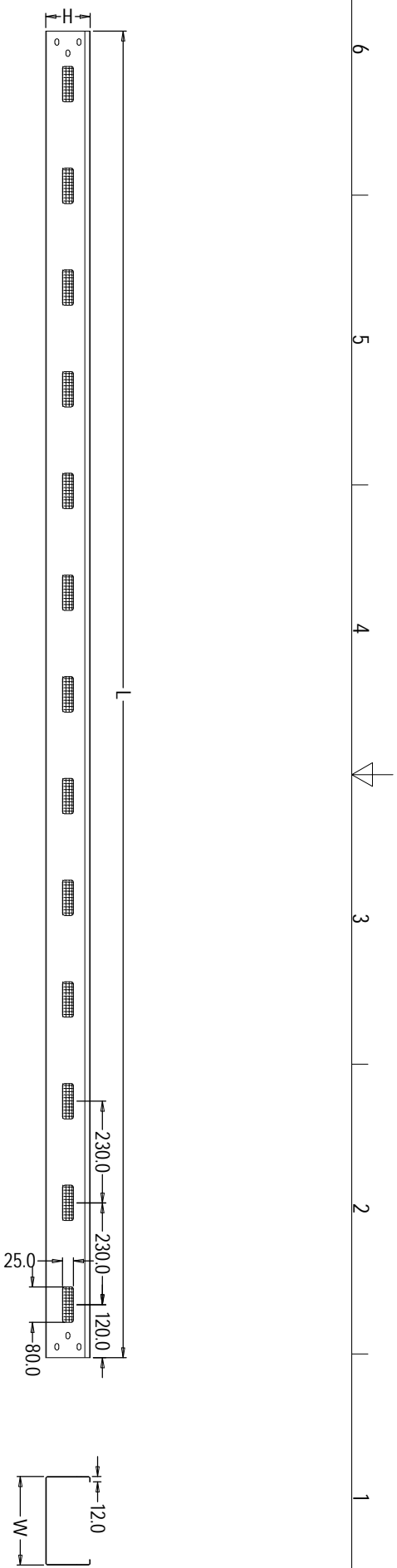

### Máng cáp dập gân - Ribbed cable tray

Mã số Catalog Code	Rộng - Width (W1=W2)	Cao - Height (H)	Dài - Length (L)	Dày - Thickness (mm)
L- RTR- WxHxT	50,75,100,150, 200,300,400,500, 600,700,800, 900,1000	50, 75, 100, 150, 200		0,8, 1,0, 1,2, 1,5, 2,0

Designed by

Checked by

Approved by

Date

Date

A



CÔNG TY TNHH KỸ THUẬT  
DƯƠNG HÙNG DHE

Edition

Sheet  
1 / 1

6

5

4

3

2

1

A

B

C

D

6

5

4

3

2

1



6

5

4

3

2

1

D

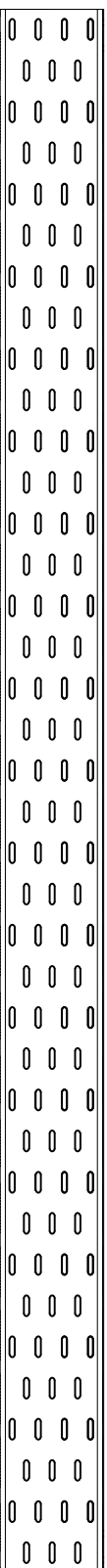

C

### Hộp cáp thẳng - Straight Tray

Mã số Catalog Code	Rộng - Width (W1=W2)	Cao - Height (H)	Dài - Length (L)	Dày - Thickness (mm)
L-TRS-WxHxT	50, 75, 100, 150, 200, 300, 400, 500, 600, 700, 800, 900, 1000	50, 75, 100, 150, 200	3000	0.8, 1.0, 1.2, 1.5, 2.0, 2.5, 3.

B

A

6

5

4

3

2

1

A

B

C

D

Designed by

Checked by

Approved by

Date

Date



CÔNG TY TNHH KỸ THUẬT  
DƯƠNG HÙNG DHE

Edition

Sheet  
1 / 1

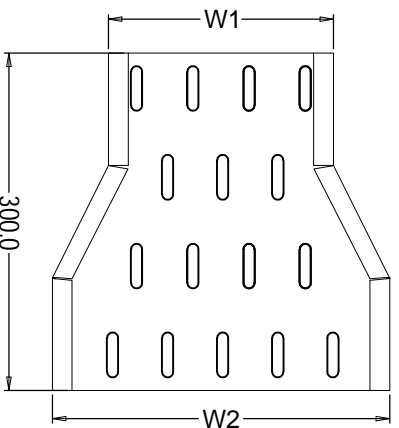
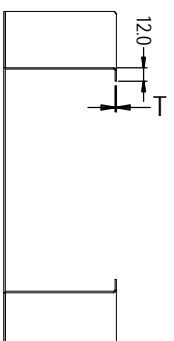
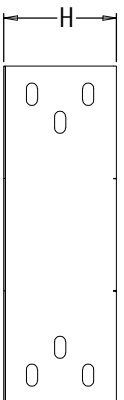

### Giảm cấp hai bên - Offset reducer

Mã số Catalog Code	Rộng - Width (W1=W2)	Cao - Height (H)	Dài - Length (L)	Dày - Thickness (mm)
L-TRRO-WxHxT	50,75,100,150,200,300,400,500,600,700,800,900,1000	50,75,100,150,200	300	0,8,1,0,1,2,1,5,2,0,2,5,3.

Designed by	Checked by	Approved by	Date	Date	Edition	Sheet
						1 / 1



CÔNG TY TNHH KỸ THUẬT  
DƯƠNG HÙNG DHE

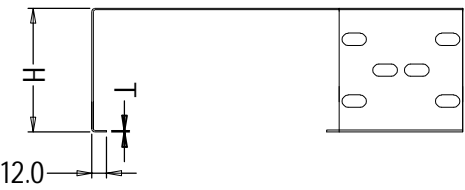
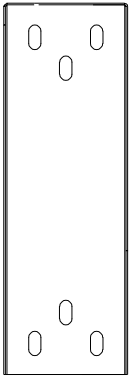
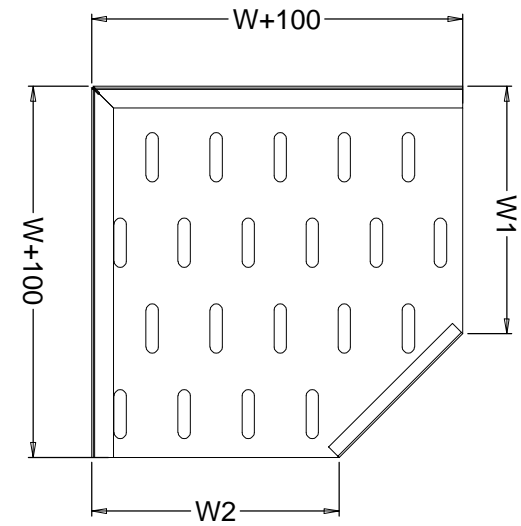

<b>Co ngang 90° - 90° Elbow</b>				
Mã số Catalog Code	Rộng - Width (W1=W2)	Cao - Height (H)	Dài - Length (L)	Dày - Thickness (mm)
L-TRE- WxHxT	50,75, 100,150, 200,300,400,500, 600,700, 800, 900,1000	50, 75, 100, 150, 200		0,8, 1,0, 1,2, 1,5, 2,0 2,5, 3,

Designed by	Checked by	Approved by	Date	Date	Edition	Sheet
						1 / 1



**CÔNG TY TNHH KỸ THUẬT ĐƯỜNG HÙNG DHE**

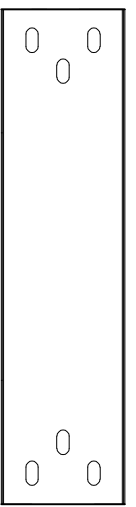
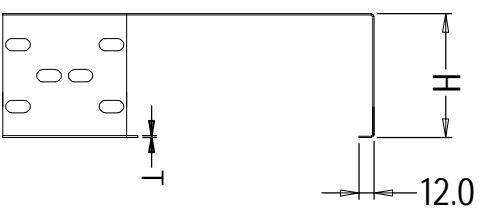
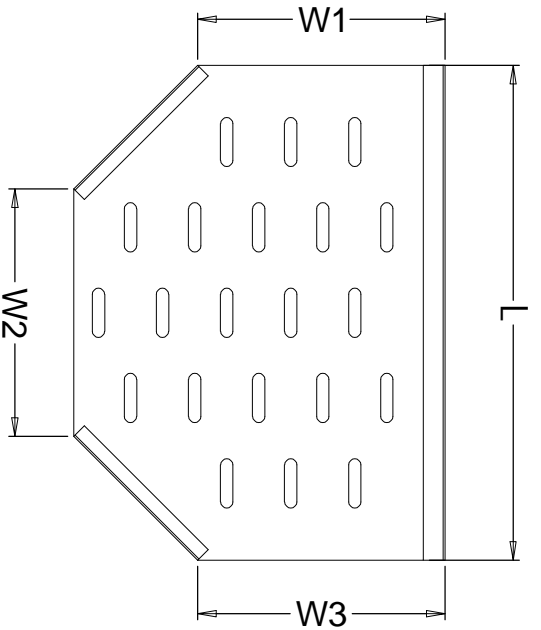

Tee rộng bằng nhau - Equal Tee				
Mã số Catalog Code	Rộng - Width (W1=W2)	Cao - Height (H)	Dài - Length (L)	Dày - Thickness (mm)
L-TRT-WxHxT	50,75,100,150, 200,300,400,500, 600,700,800, 900,1000	50, 75, 100, 150, 200		0,8, 1,0, 1,2, 1,5, 2,0 2,5, 3.

Designed by	Checked by	Approved by	Date	Date	Edition	Sheet
						1 / 1



CÔNG TY TNHH KỸ THUẬT  
ĐƯỜNG HÙNG DHE

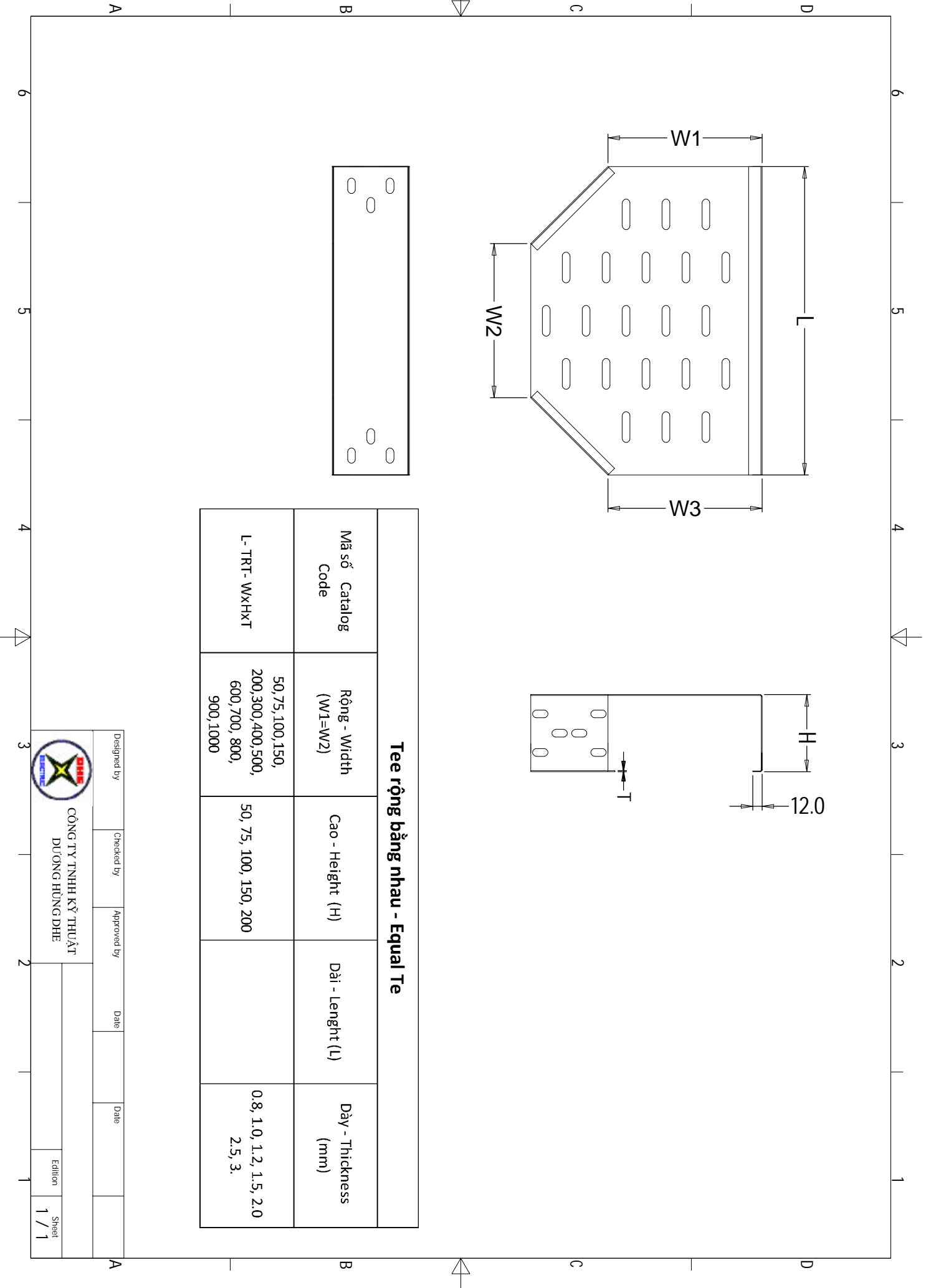

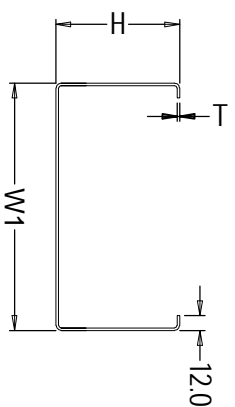
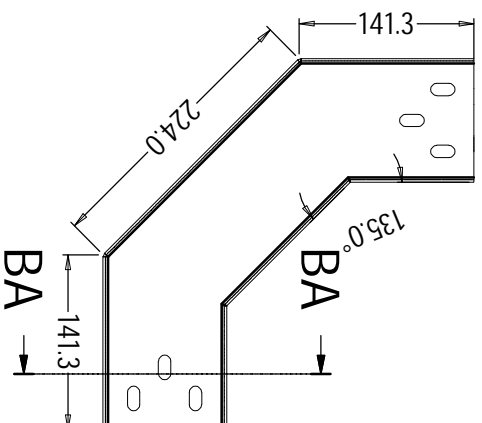

BA-BA ( 1 : 6 )

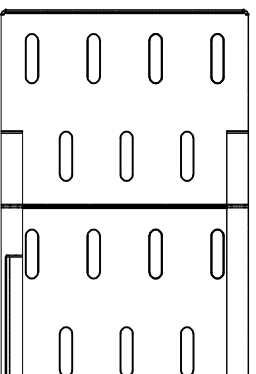

Cổ đứng bên trong - Internal riser				
Mã số Catalog Code	Rộng - Width (W1=W2)	Cao - Height (H)	Dài - Length (L)	Dày - Thickness (mm)
L-TRIR-WXHX-T	50, 75, 100, 150, 200, 300, 400, 500, 600, 700, 800, 900, 1000	50, 75, 100, 150, 200		0.8, 1.0, 1.2, 1.5, 2.0, 2.5, 3.

Designed by	Checked by	Approved by	Date	Date	Edition	Sheet
						1 / 1



CÔNG TY TNHH KỸ THUẬT  
ĐƯỜNG HÙNG DHE

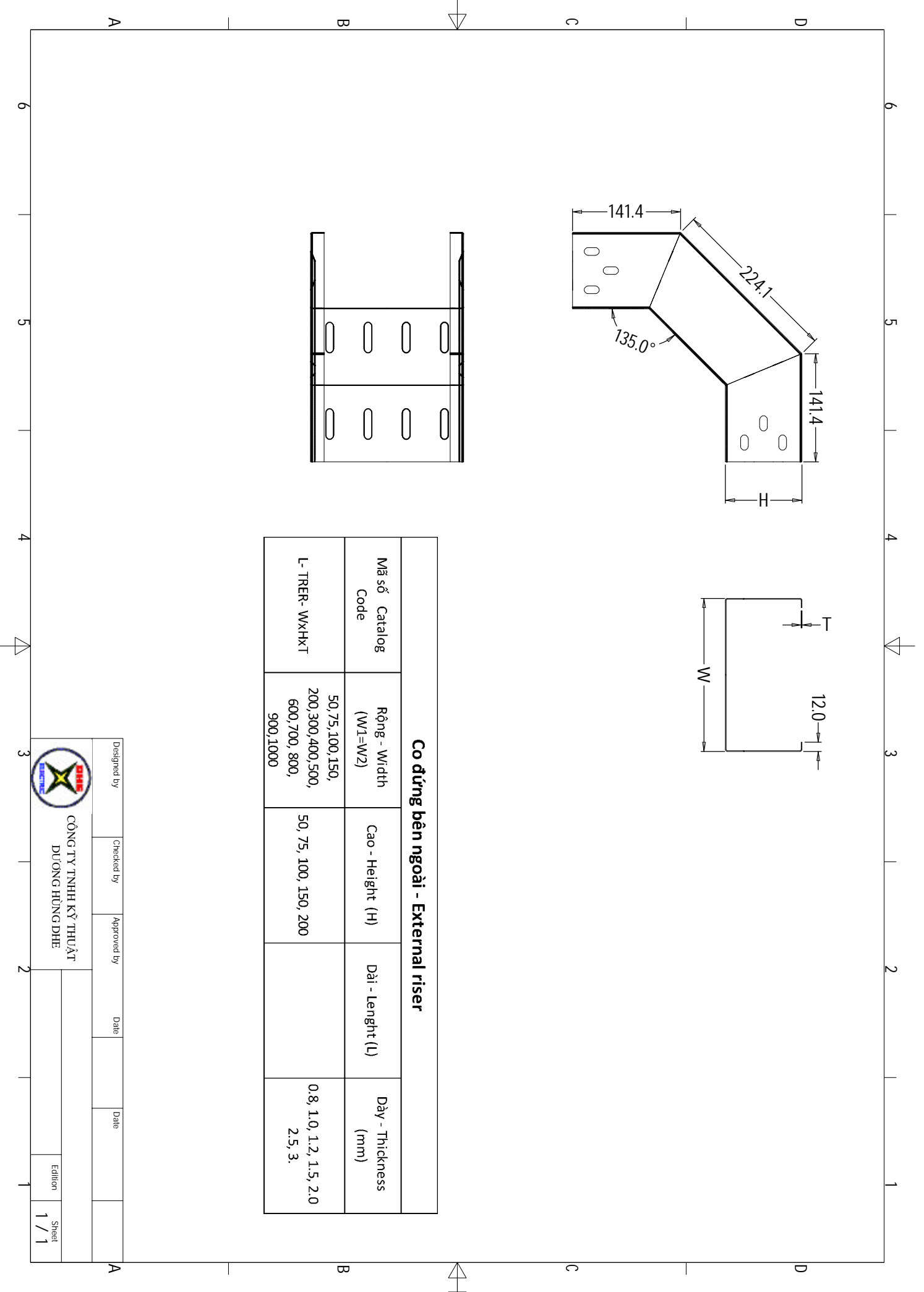

**Co đứng bên ngoài - External riser**

Mã số Catalog Code	Rộng - Width (W1=W2)	Cao - Height (H)	Dài - Length (L)	Dày - Thickness (mm)
L-TRER-WXHX-T	50,75,100,150,200,300,400,500,600,700,800,900,1000	50,75,100,150,200		0,8,1,0,1,2,1,5,2,0,2,5,3.

Designed by	Checked by	Approved by	Date	Date	Edition	Sheet
						1 / 1



CÔNG TY TNHH KỸ THUẬT  
ĐƯỜNG HÙNG DHE



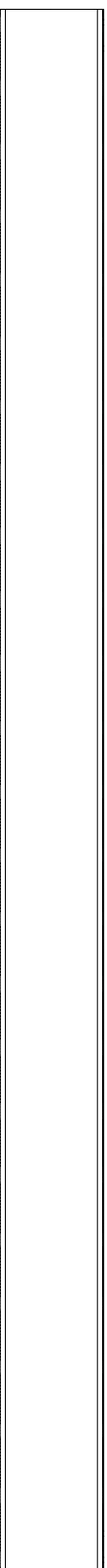
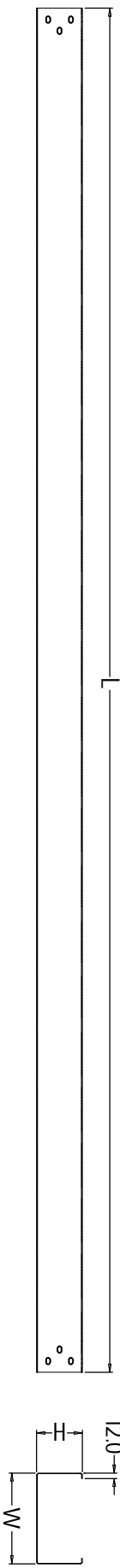

### Hộp cáp thẳng - Straight Trunking

Mã số Catalog Code	Rộng - Width (W1=W2)	Cao - Height (H)	Dài - Length (L)	Dày - Thickness (mm)
L- TKS- WxHxT	50, 75, 100, 150, 200, 300, 400, 500, 600, 700, 800, 900, 1000	50, 75, 100, 150, 200	3000	0.8, 1.0, 1.2, 1.5, 2.0, 2.5, 3.

Designed by	Checked by	Approved by	Date	Date	Edition	Sheet
						1 / 1



CÔNG TY TNHH KỸ THUẬT  
DƯƠNG HƯNG DHE

# Nắp máng

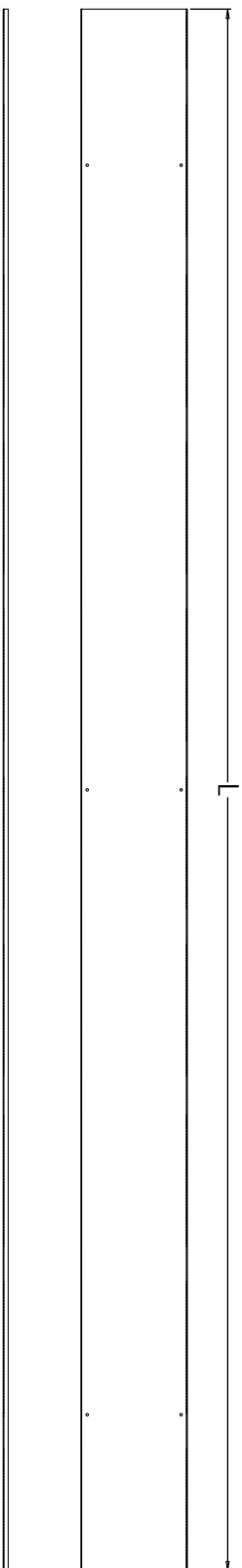

W+3  
12.0

Designed by	Checked by	Approved by	Date	Date	Edition	Sheet
					1 / 1	1 / 1

  
CÔNG TY TNHH KỸ THUẬT  
DỰNG HÙNG DHE

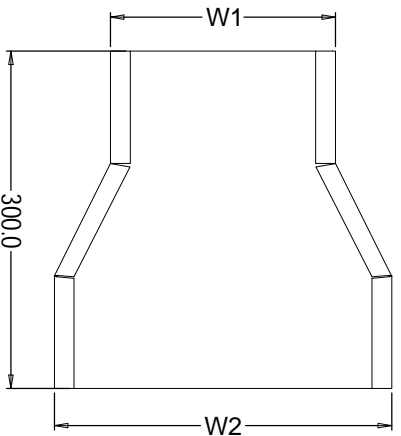
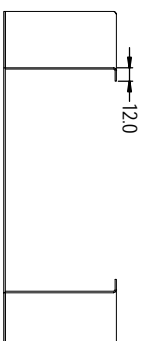
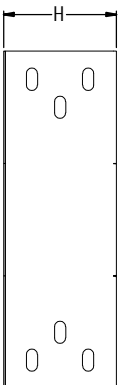

### Giảm cấp hai bên - Offset reducer

Mã số Catalog Code	Rộng - Width (W1=W2)	Cao - Height (H)	Dài - Length (L)	Đáy - Thickness (mm)
L- TKRO- WxHxT	50, 75, 100, 150, 200, 300, 400, 500, 600, 700, 800, 900, 1000	50, 75, 100, 150, 200	300	0,8, 1,0, 1,2, 1,5, 2,0, 2,5, 3.

Designed by	Checked by	Approved by	Date	Date	Edition	Sheet
						1 / 1



CÔNG TY TNHH KỸ THUẬT  
DƯƠng HÙNG DHE

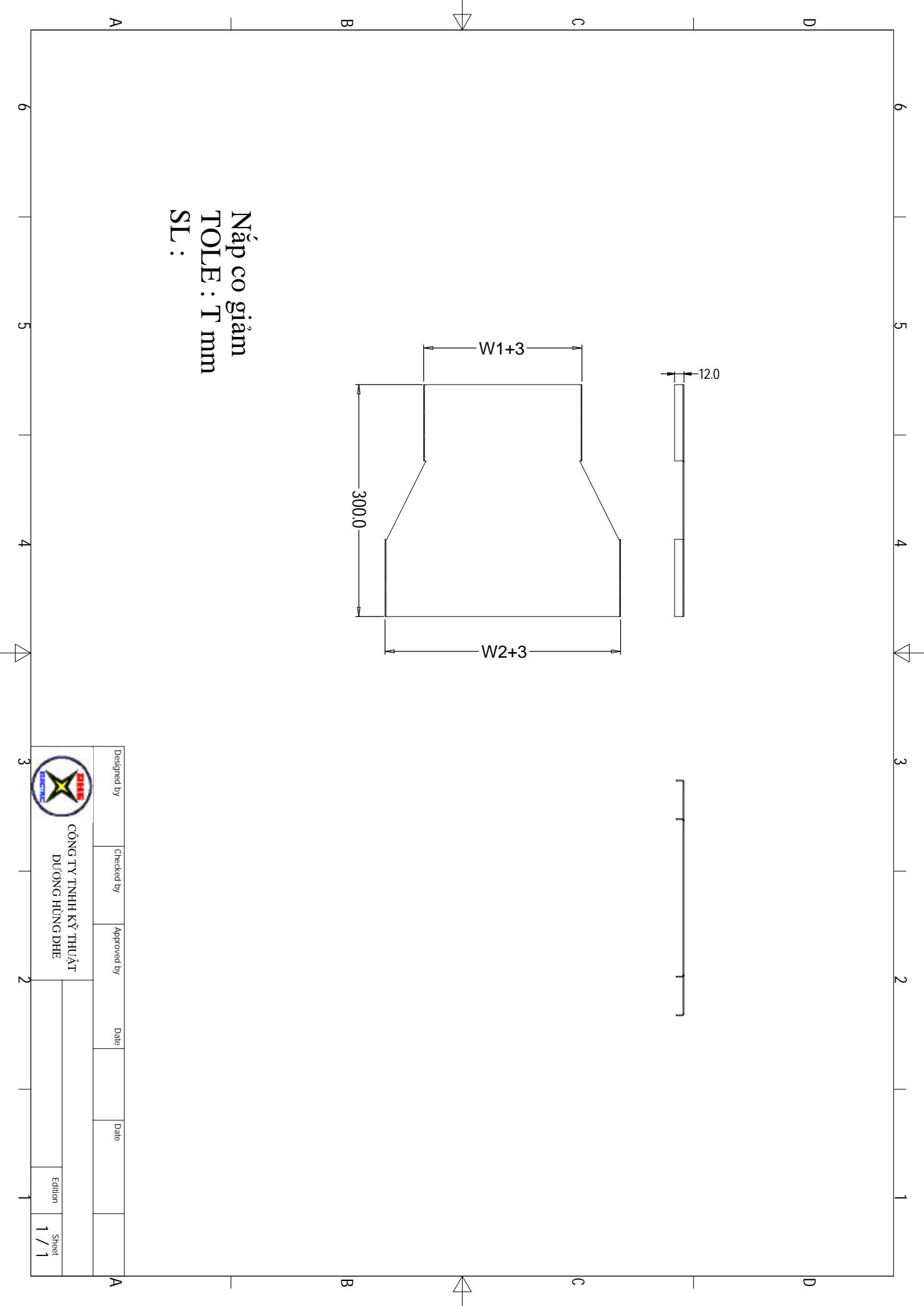

Nắp co giảm  
 TOLE : T mm  
 SL :

Designed by	Checked by	Approved by	Date	Date	Edition	Sheet
					1	1 / 1
CÔNG TY TNHH KỸ THUẬT DƯỜNG HÙNG DHE						

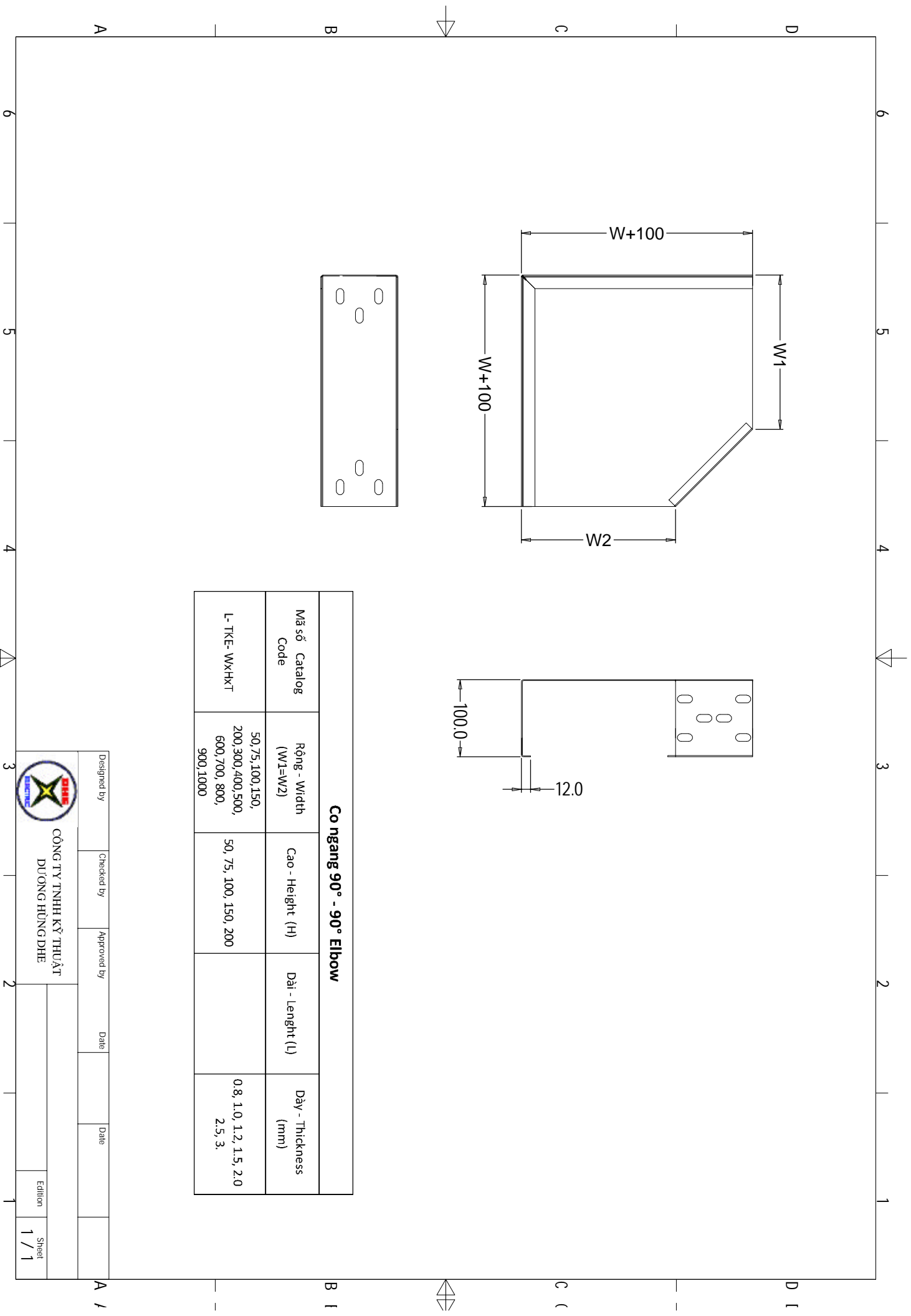

**Co ngang 90° - 90° Elbow**

Mã số Catalog Code	Rộng - Width (W1=W2)	Cao - Height (H)	Dài - Length (L)	Dày - Thickness (mm)
L-TKE-WXHX-T	50, 75, 100, 150, 200, 300, 400, 500, 600, 700, 800, 900, 1000	50, 75, 100, 150, 200		0,8, 1,0, 1,2, 1,5, 2,0, 2,5, 3.

Designed by	Checked by	Approved by	Date	Date	Edition	Sheet
						1 / 1

**CÔNG TY TNHH KỸ THUẬT ĐƯỜNG HÙNG DHE**

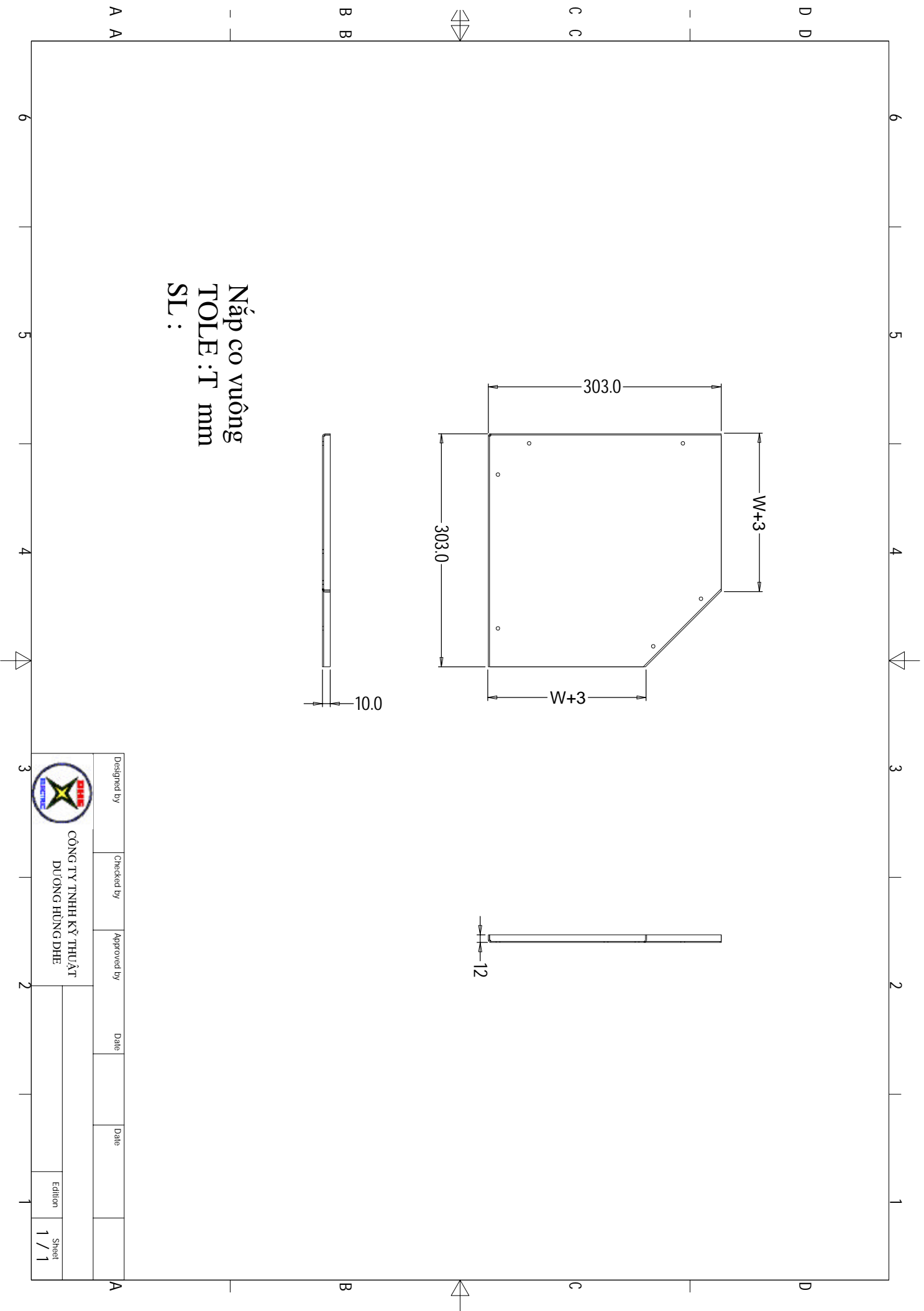

Nắp co vuông  
TOLE: T mm  
SL:

Designed by	Checked by	Approved by	Date	Date	Edition	Sheet
						1 / 1
CÔNG TY TNHH KỸ THUẬT DƯỜNG HÙNG DHE						

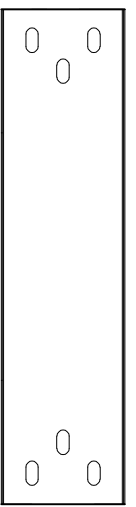
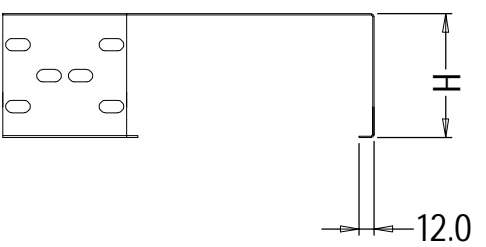
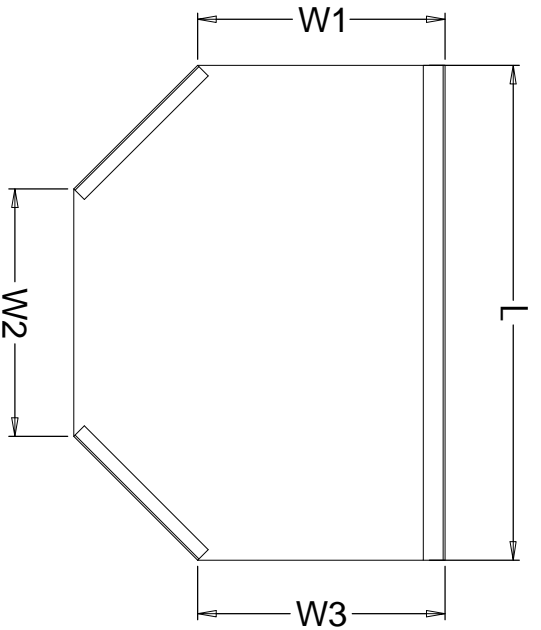

Tee rộng bằng nhau - Equal Te				
Mã số Catalog Code	Rộng - Width ( $W1=W2$ )	Cao - Height (H)	Dài - Length (L)	Dày - Thickness (mm)
L- TKT- WxHxT	50, 75, 100, 150, 200, 300, 400, 500, 600, 700, 800, 900, 1000	50, 75, 100, 150, 200		0,8, 1,0, 1,2, 1,5, 2,0 2,5, 3,

Designed by	Checked by	Approved by	Date	Date	Edition	Sheet
						1 / 1



CÔNG TY TNHH KỸ THUẬT  
ĐƯỜNG HÙNG DHE

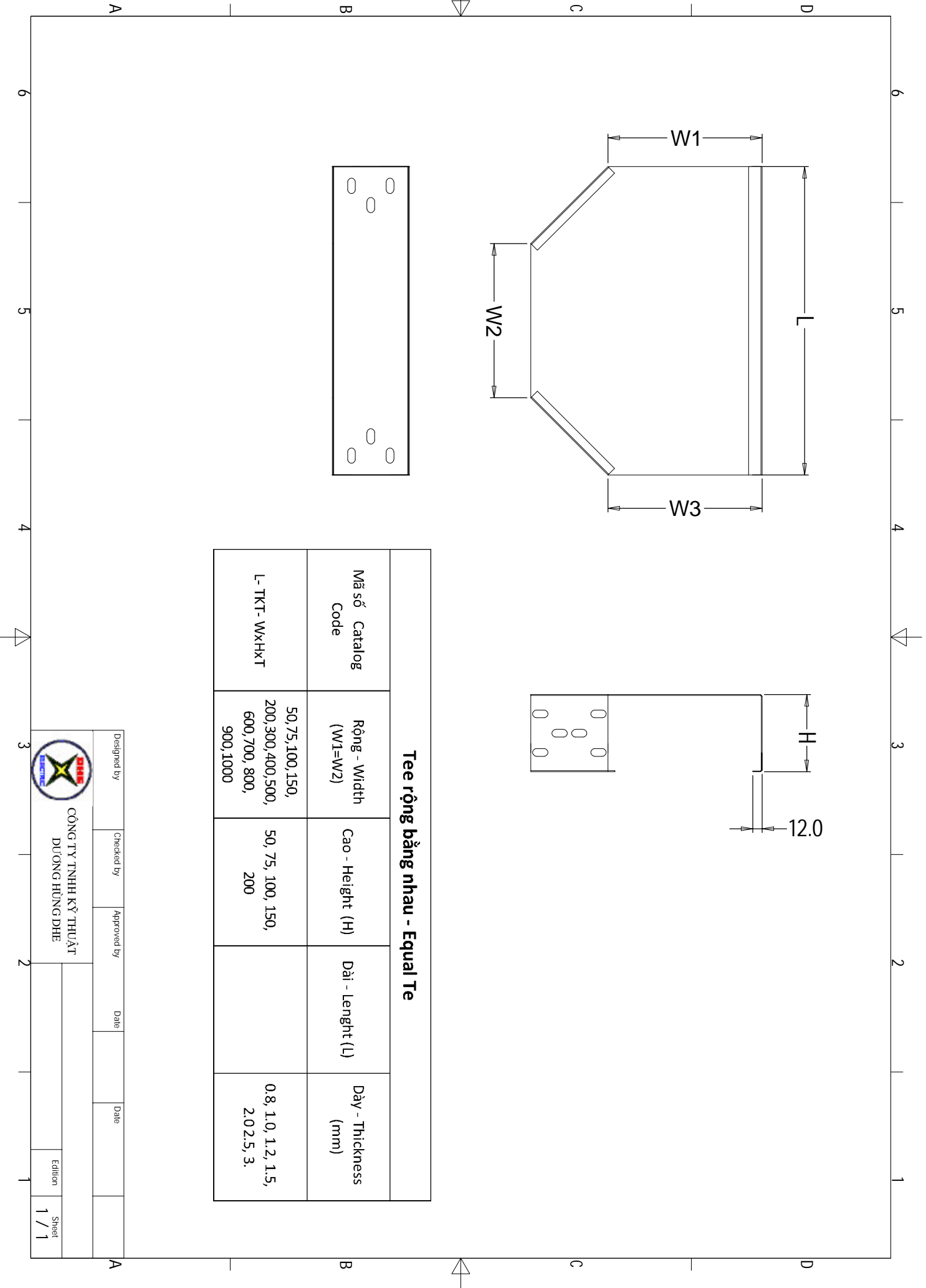

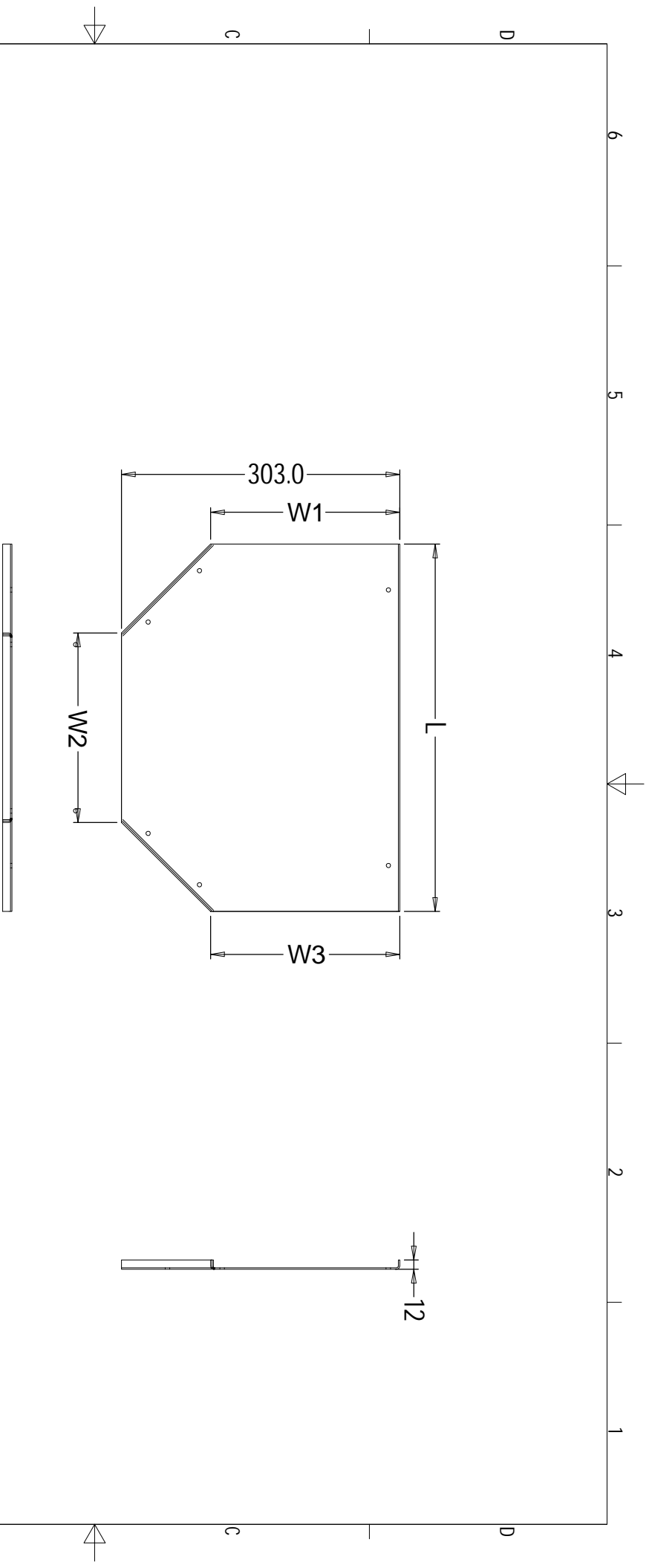

Nắp co T  
 TOLE : T mm  
 SL :

6	5	4	3	2	1
A	B	C	D	A	B
Designed by		Checked by		Approved by	
Date		Date		Date	
 CÔNG TY TNHH KỸ THUẬT DƯỜNG HÙNG DHE					
Edition			Sheet		
1 / 1			1 / 1		



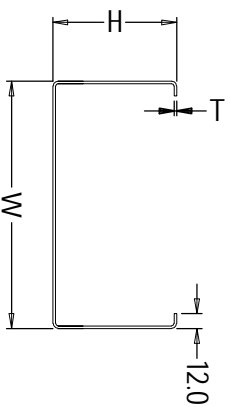
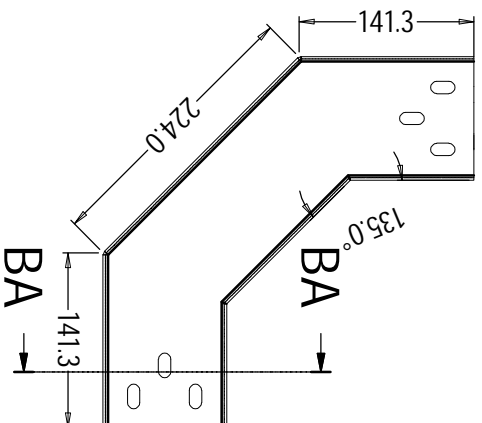

BA-BA ( 1 : 6 )

**Co đưng bên trong - Internal riser**

Mã số Catalog Code	Rộng - Width (W1=W2)	Cao - Height (H)	Dài - Length (L)	Dày - Thickness (mm)
L-TKTIR- WxHxT	50, 75, 100, 150, 200, 300, 400, 500, 600, 700, 800, 900, 1000	50, 75, 100, 150, 200		0,8, 1,0, 1,2, 1,5, 2,0, 2,5, 3.

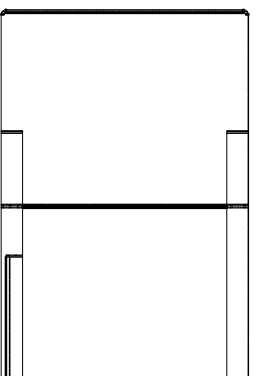

A

B

C

D

6

5

4

3

2

1

Designed by

Checked by

Approved by

Date

Date

A

B

C

D



CÔNG TY TNHH KỸ THUẬT  
ĐƯỜNG HÙNG DHE

Edition

Sheet  
1 / 1

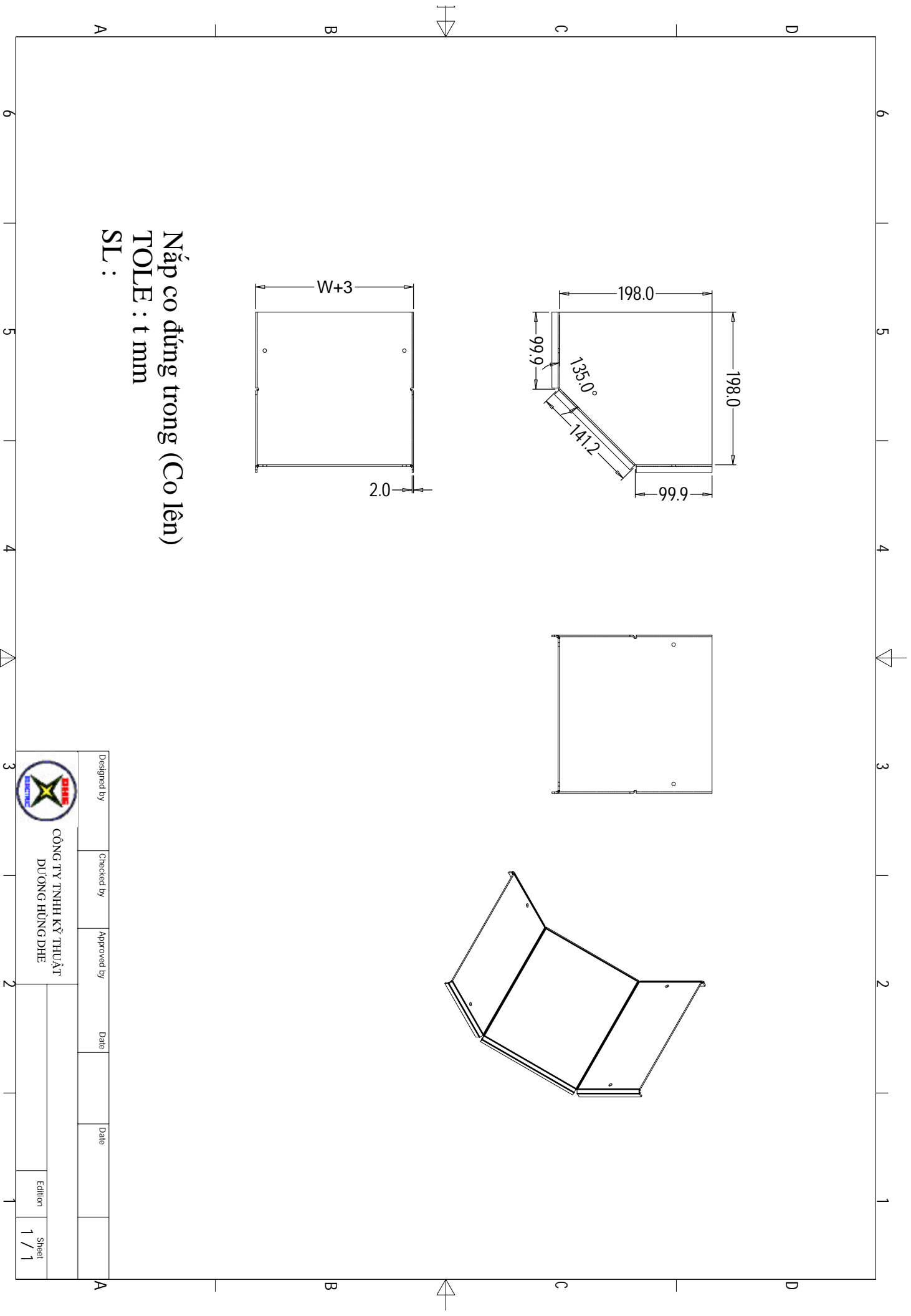

Nắp co đứng trong (Co lên)  
 TOLE : t mm  
 SL :

Designed by	Checked by	Approved by	Date	Date	Edition	Sheet
					1	1 / 1



CÔNG TY TNHH KỸ THUẬT  
 DƯƠNG HÙNG DHE

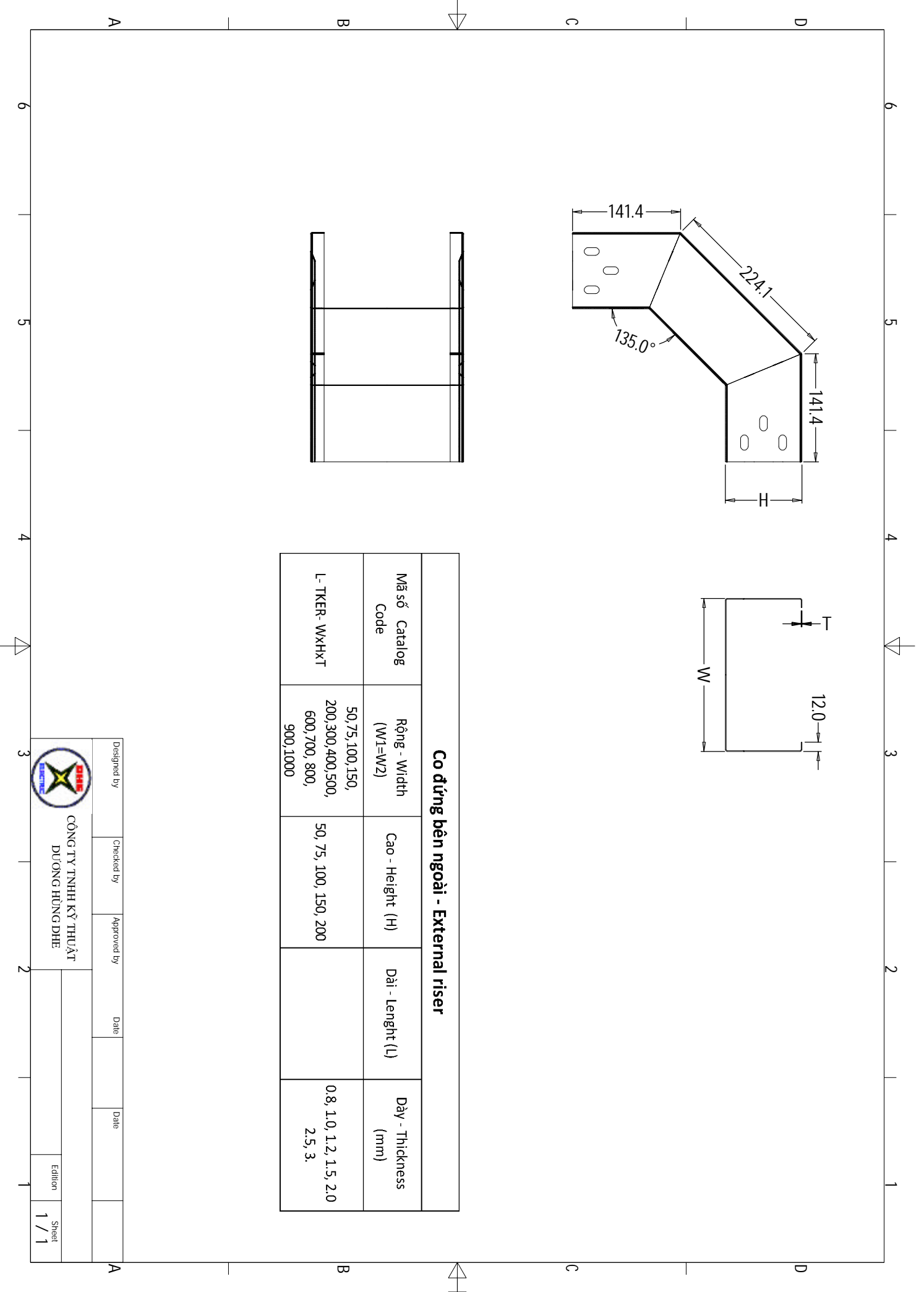

**Cơ đứng bên ngoài - External riser**

Mã số Catalog Code	Rộng - Width (W1=W2)	Cao - Height (H)	Dài - Length (L)	Dày - Thickness (mm)
L-TKER-WXHX-T	50, 75, 100, 150, 200, 300, 400, 500, 600, 700, 800, 900, 1000	50, 75, 100, 150, 200		0.8, 1.0, 1.2, 1.5, 2.0, 2.5, 3.

Designed by	Checked by	Approved by	Date	Date	Edition	Sheet
						1 / 1

  
**CÔNG TY TNHH KỸ THUẬT ĐƯỜNG HÙNG DHE**

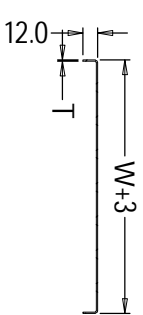
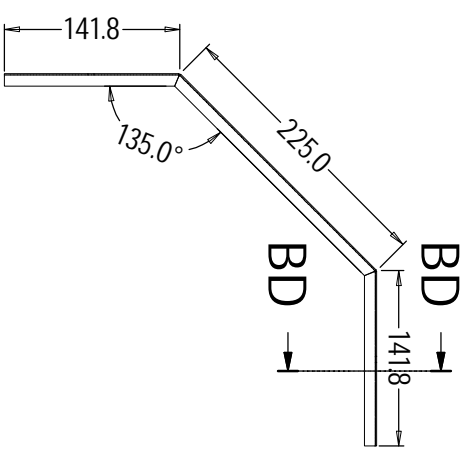

BD-BD ( 1 : 6 )

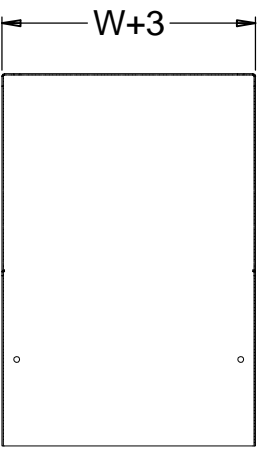

Nắp co đống ngoài (co xuồng)  
 TOLE : t mm  
 SL :

Designed by	Checked by	Approved by	Date	Date	Edition	Sheet
						1 / 1
CÔNG TY TNHH KỸ THUẬT DƯ ÔNG HÙNG DHE						

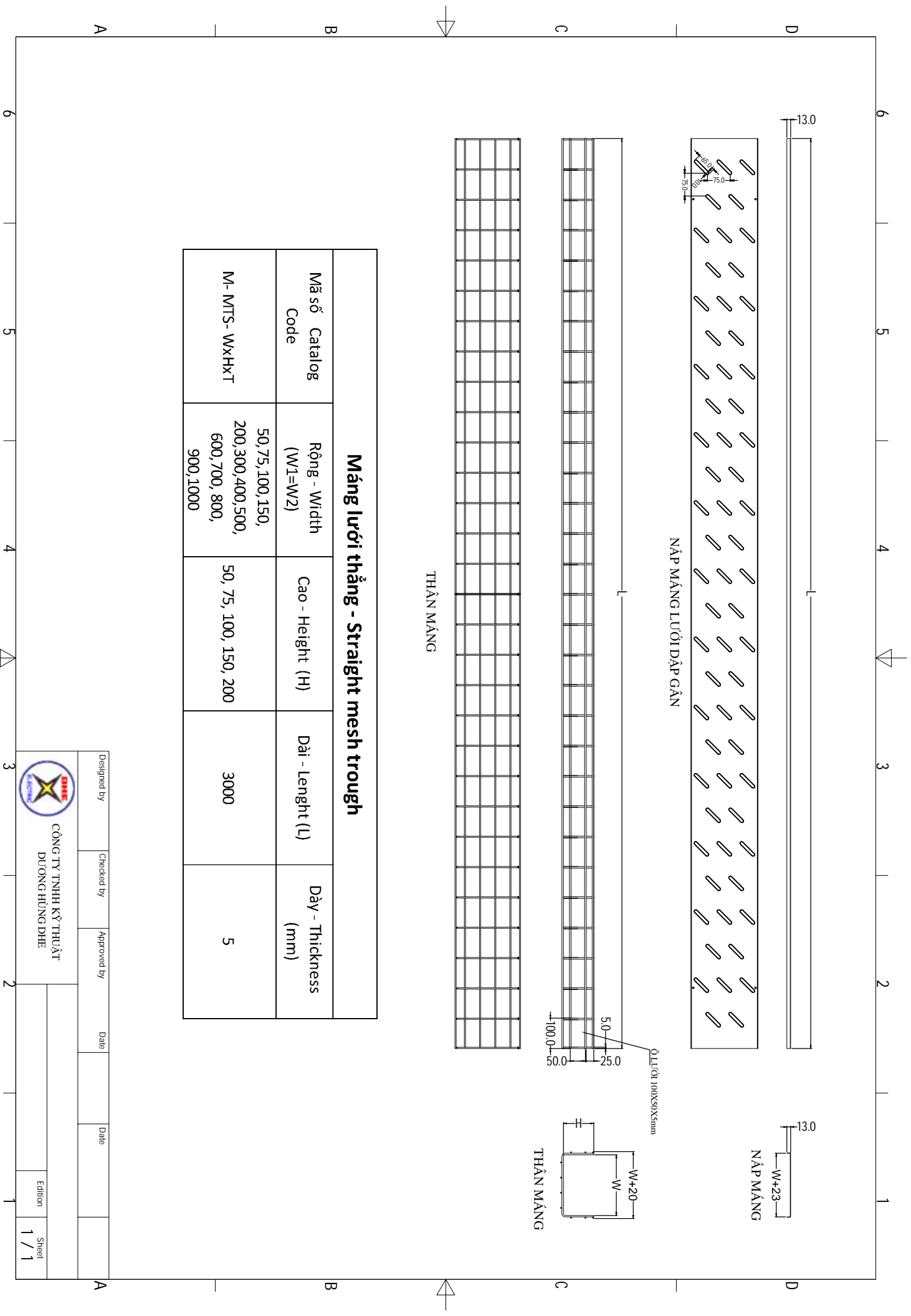

**Màng lưới thẳng - Straight mesh trough**

Mã số Catalog Code	Rộng - Width (W1=W2)	Cao - Height (H)	Dài - Length (L)	Dày - Thickness (mm)
M- MTS- WxHxT	50, 75, 100, 150, 200, 300, 400, 500, 600, 700, 800, 900, 1000	50, 75, 100, 150, 200	3000	5

Designed by	Checked by	Approved by	Date	Date
 <b>CÔNG TY TNHH KỸ THUẬT ĐƯỜNG HÙNG DHE</b>				
Edition				Sheet
				1 / 1

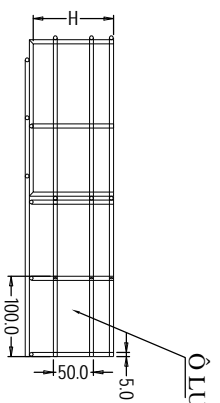

Ô LƯỚI 100X50X5mm

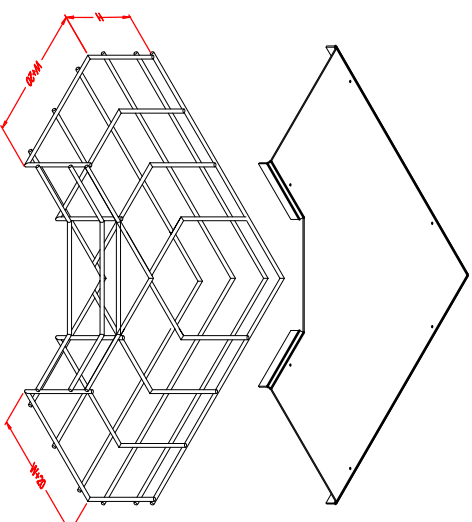
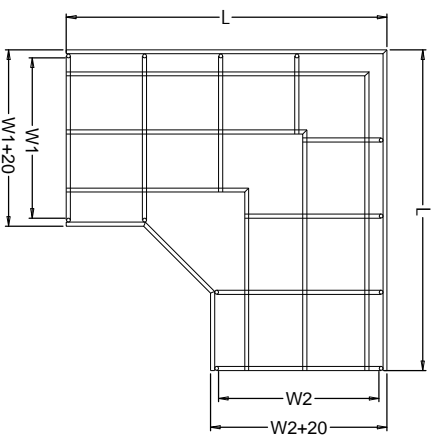
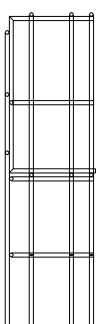

### Co ngang 90° - 90° Elbow

Mã số Catalog Code	Rộng - Width (W1=W2)	Cao - Height (H)	Dài - Length (L)	Dày - Thickness (mm)
M - MTE - WxHxT	50, 75, 100, 150, 200, 300, 400, 500, 600, 700, 800, 900, 1000	50, 75, 100, 150, 200		5

Designed by

Checked by

Approved by

Date

Date



CÔNG TY TNHH KỸ THUẬT  
DƯƠNG HƯNG DHE

Edition

Sheet  
1 / 1

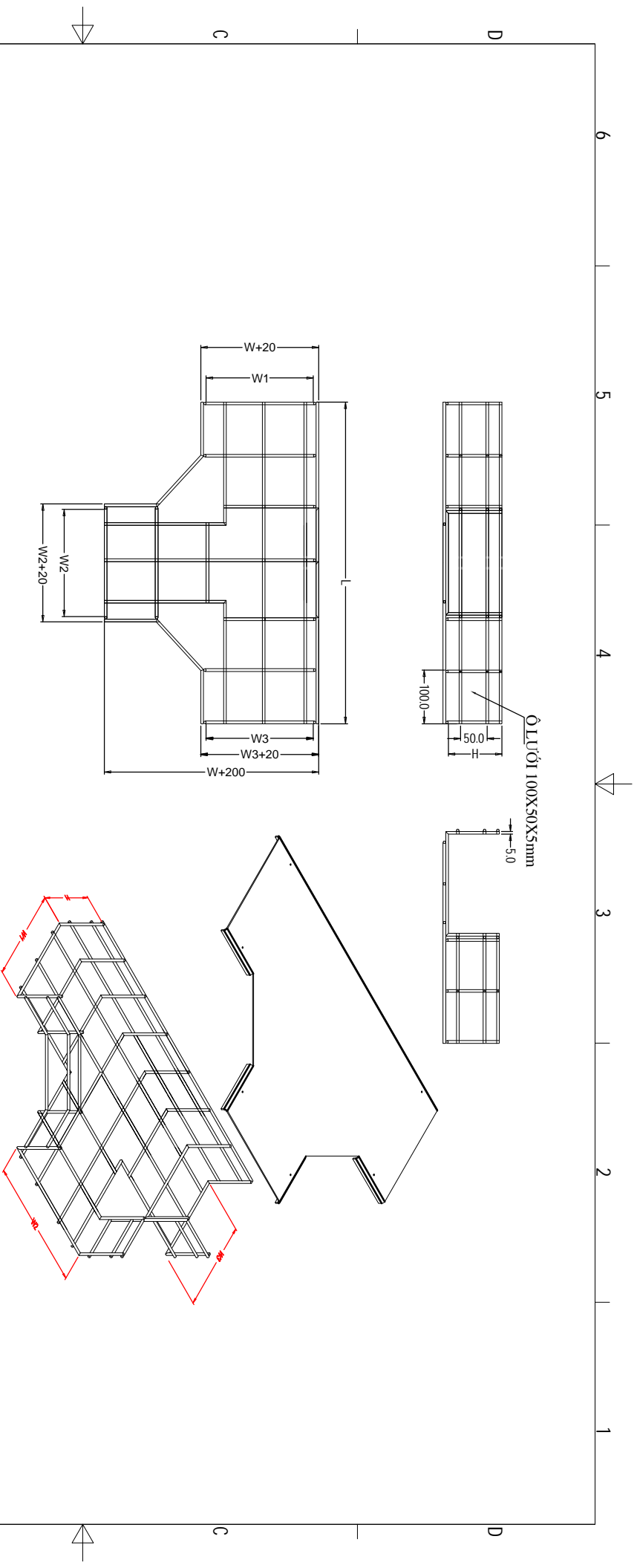

**Tee rộng bằng nhau**

Mã số Catalog Code	Rộng - Width (W1-W2)	Cao - Height (H)	Dài - Length (L)	Dày - Thickness (mm)
M-MTT-WXHXT	50,75,100,150, 200,300,400,500, 600,700,800, 900,1000	50, 75, 100, 150, 200		5

Designed by \_\_\_\_\_ Checked by \_\_\_\_\_ Approved by \_\_\_\_\_ Date \_\_\_\_\_ Date \_\_\_\_\_



CÔNG TY TNHH KỸ THUẬT  
DƯƠNG HÙNG DHE

Edition

Sheet  
1 / 1

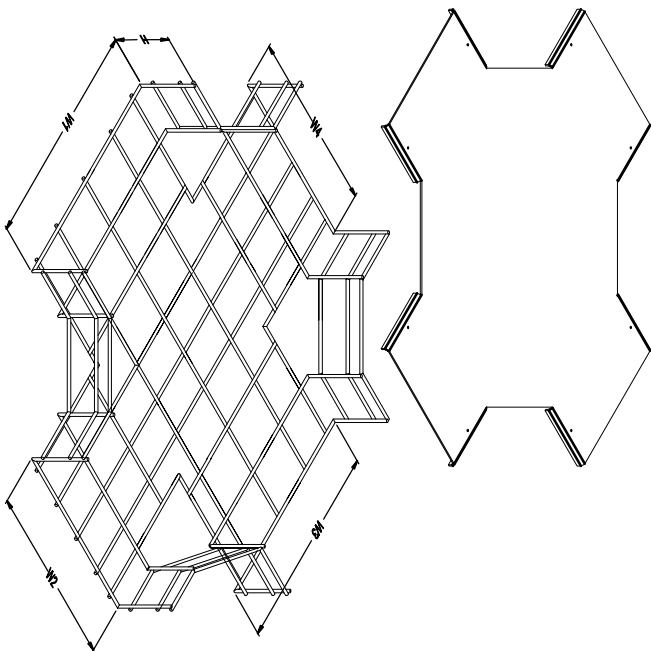
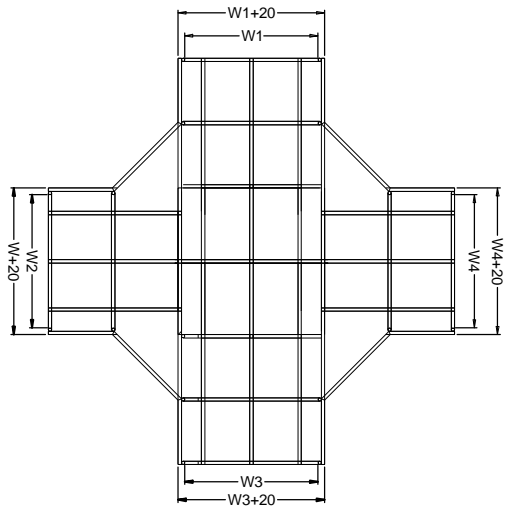
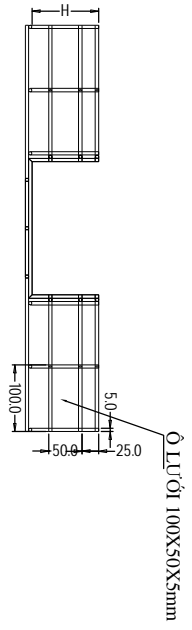

**Ngã tư rộng bằng nhau**

Mã số Catalog Code	Rộng - Width (W1=W2)	Cao - Height (H)	Dài - Length (L)	Dày - Thickness (mm)
M- MTX- WxHxT	50, 75, 100, 150, 200, 300, 400, 500, 600, 700, 800, 900, 1000	50, 75, 100, 150, 200		5

A

B

C

D

6

5

4

3

2

1

Designed by

Checked by

Approved by

Date

Date

Edition

Sheet



**CÔNG TY TNHH KỸ THUẬT  
DƯƠNG HÙNG DHE**

1 / 1

6

5

4

3

2

1



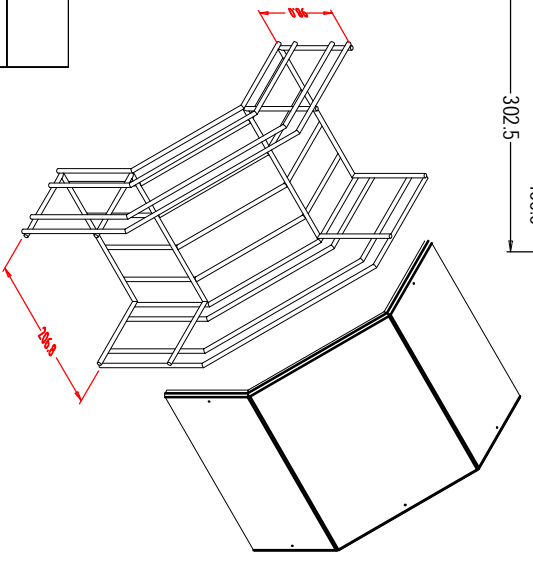
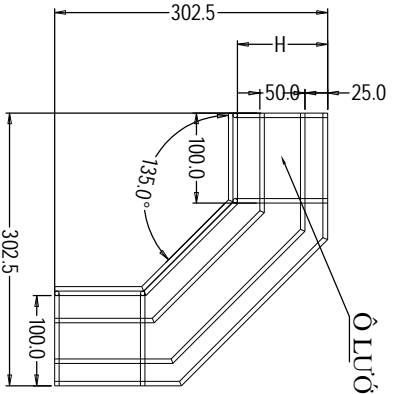
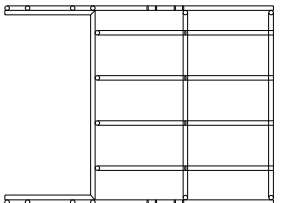
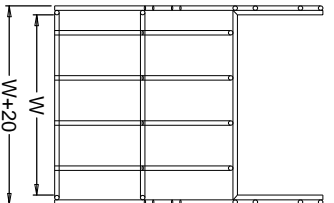

**Co đứng bên ngoài - External riser**

Mã số Catalog Code	Rộng - Width (W1=W2)	Cao - Height (H)	Dài - Length (L)	Dày - Thickness (mm)
M-MTER-WxHxT	50, 75, 100, 150, 200, 300, 400, 500, 600, 700, 800, 900, 1000	50, 75, 100, 150, 200		5

Designed by	Checked by	Approved by	Date	Date	Edition	Sheet
					1	1 / 1

**CÔNG TY TNHH KỸ THUẬT DƯƠNG HƯNG DHE**

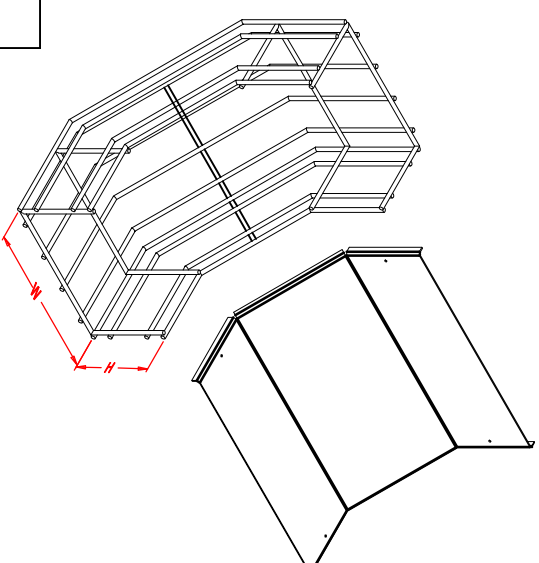
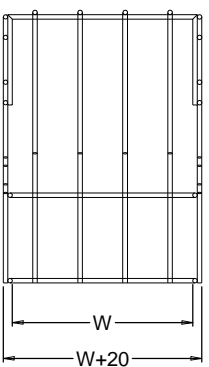
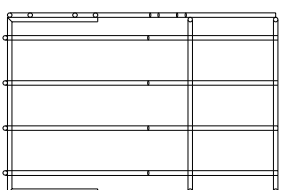
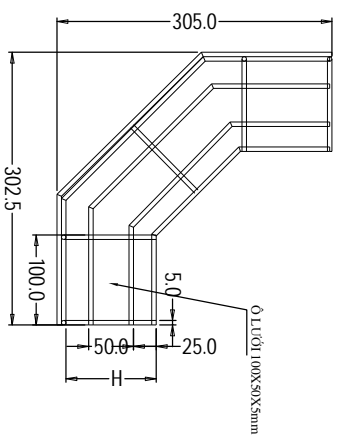

### Co đứng bên trong - Internal riser

Mã số Catalog Code	Rộng - Width (W1=W2)	Cao - Height (H)	Dài - Length (L)	Dày - Thickness (mm)
M- MTR- WxHxT	50, 75, 100, 150, 200, 300, 400, 500, 600, 700, 800, 900, 1000	50, 75, 100, 150, 200		5

Designed by

Checked by

Approved by

Date

Date

Edition

Sheet



CÔNG TY TNHH KỸ THUẬT  
DƯƠNG HÙNG DHE

1 / 1

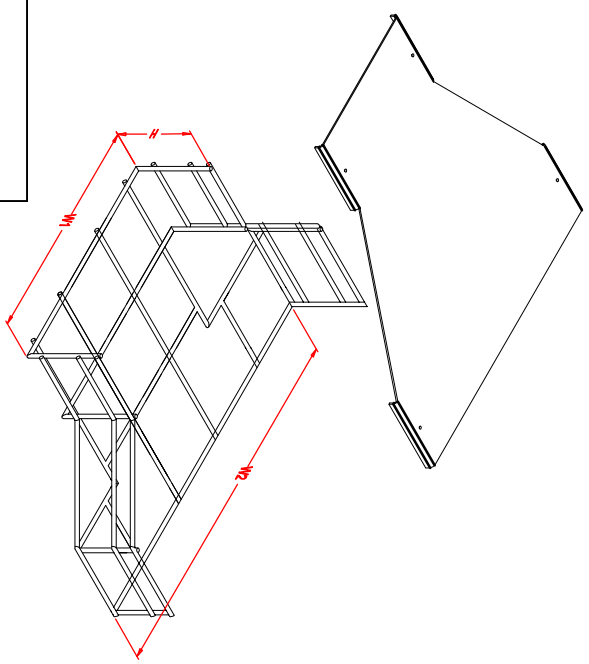
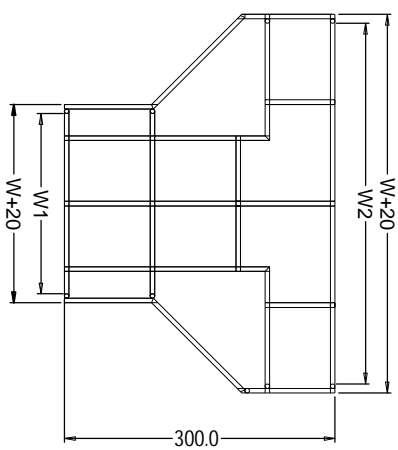
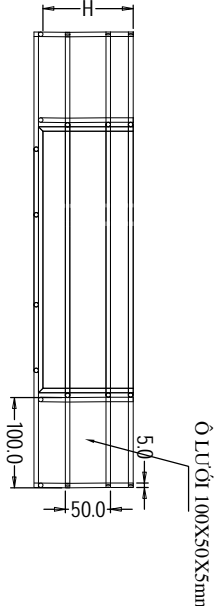

**Giảm cấp hai bên - Offset reducer**

Mã số Catalog Code	Rộng - Width (W1=W2)	Cao - Height (H)	Dài - Length (L)	Dày - Thickness (mm)
M- MTR0- WxHxT	50, 75, 100, 150, 200, 300, 400, 500, 600, 700, 800, 900, 1000	50, 75, 100, 150, 200	300	5

Designed by: \_\_\_\_\_ Checked by: \_\_\_\_\_ Approved by: \_\_\_\_\_ Date: \_\_\_\_\_ Date: \_\_\_\_\_



**CÔNG TY TNHH KỸ THUẬT DƯƠNG HÙNG DHE**

Edition 1 / 1

Sheet 1 / 1